

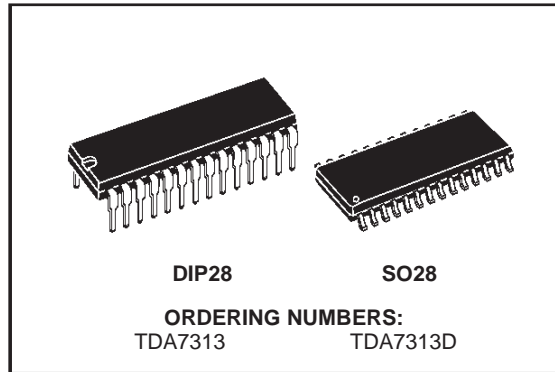

# TDA7313

## DIGITAL CONTROLLED STEREO AUDIO PROCESSOR WITH LOUDNESS

- INPUT MULTIPLEXER:
  - 3 STEREO INPUTS
  - SELECTABLE INPUT GAIN FOR OPTIMAL ADAPTION TO DIFFERENT SOURCES
- INPUT AND OUTPUT FOR EXTERNAL EQUALIZER OR NOISE REDUCTION SYSTEM
- LOUDNESS FUNCTION
- VOLUME CONTROL IN 1.25dB STEPS
- TREBLE AND BASS CONTROL
- FOUR SPEAKER ATTENUATORS:
  - 4 INDEPENDENT SPEAKERS CONTROL IN 1.25dB STEPS FOR BALANCE AND FADER FACILITIES
  - INDEPENDENT MUTE FUNCTION
- ALL FUNCTIONS PROGRAMMABLE VIA SERIAL I<sup>2</sup>C BUS



### DESCRIPTION

The TDA7313 is a volume, tone (bass and treble) balance (Left/Right) and fader (front/rear) processor for quality audio applications in car radio and Hi-Fi

systems.

Selectable input gain and external loudness function are provided. Control is accomplished by serial I<sup>2</sup>C bus microprocessor interface.

The AC signal setting is obtained by resistor networks and switches combined with operational amplifiers.

Thanks to the used BIPOLAR/CMOS Technology, Low Distortion, Low Noise and Low DC stepping are obtained.

### PIN CONNECTION (Top view)

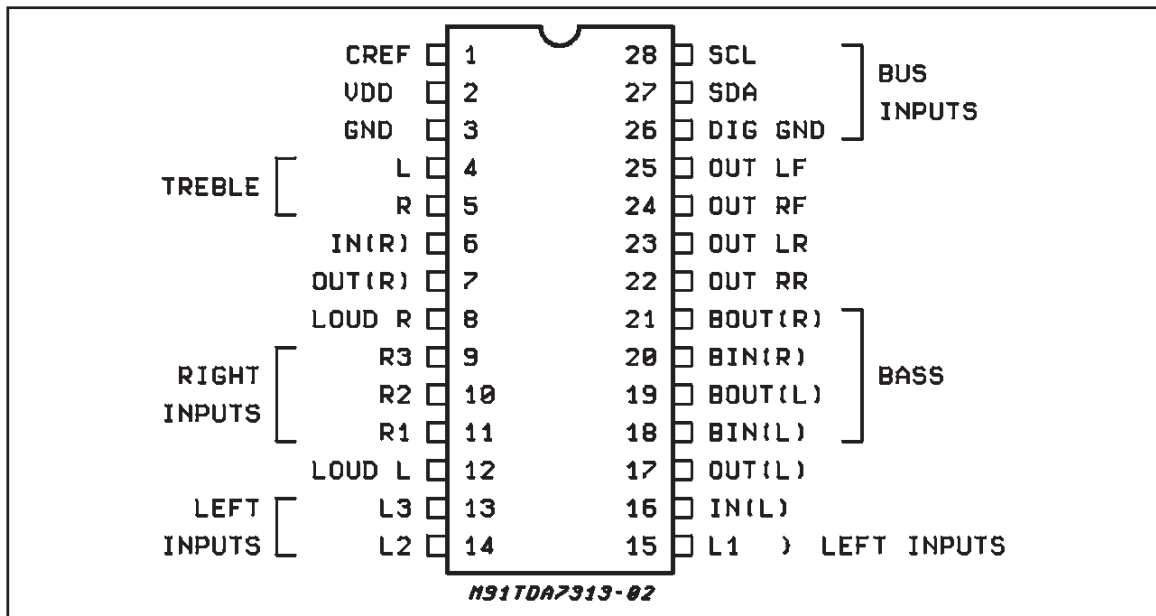

# TDA7313

## TEST CIRCUIT

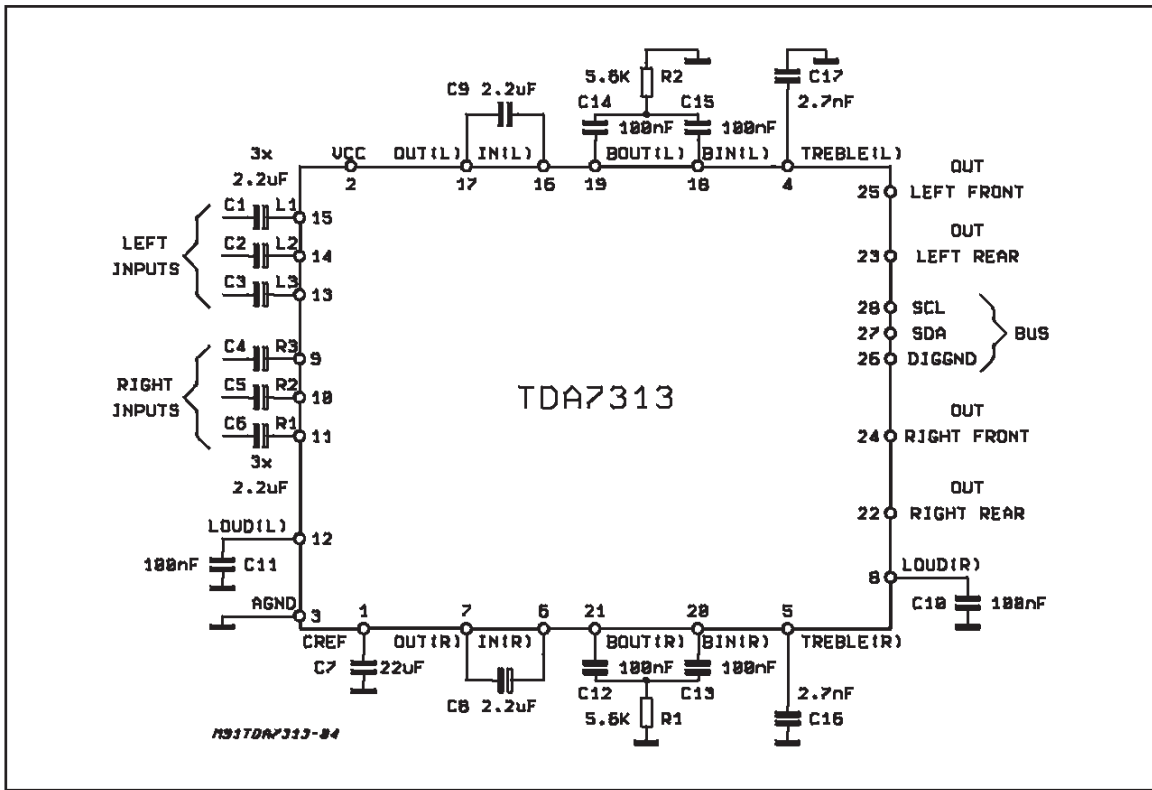

## THERMAL DATA

Symbol	Description	SO28	DIP28	Unit	
$R_{thj-pins}$	Thermal Resistance Junction-pins	max	85	65	°C/W

## ABSOLUTE MAXIMUM RATINGS

Symbol	Parameter	Value	Unit
$V_S$	Operating Supply Voltage	10.2	V
$T_{amb}$	Operating Ambient Temperature	-40 to 85	°C
$T_{stg}$	Storage Temperature Range	-55 to +150	°C

## QUICK REFERENCE DATA

Symbol	Parameter	Min.	Typ.	Max.	Unit
$V_S$	Supply Voltage	6	9	10	V
$V_{CL}$	Max. input signal handling	2			V <sub>rms</sub>
THD	Total Harmonic Distortion $V = 1V_{rms}$ $f = 1KHz$		0.01	0.1	%
S/N	Signal to Noise Ratio		106		dB
$S_C$	Channel Separation $f = 1KHz$		103		dB
	Volume Control 1.25dB step	-78.75		0	dB
	Bass and Treble Control 2db step	-14		+14	dB
	Fader and Balance Control 1.25dB step	-38.75		0	dB
	Input Gain 3.75dB step	0		11.25	dB
	Mute Attenuation		100		dB

BLOCK DIAGRAM

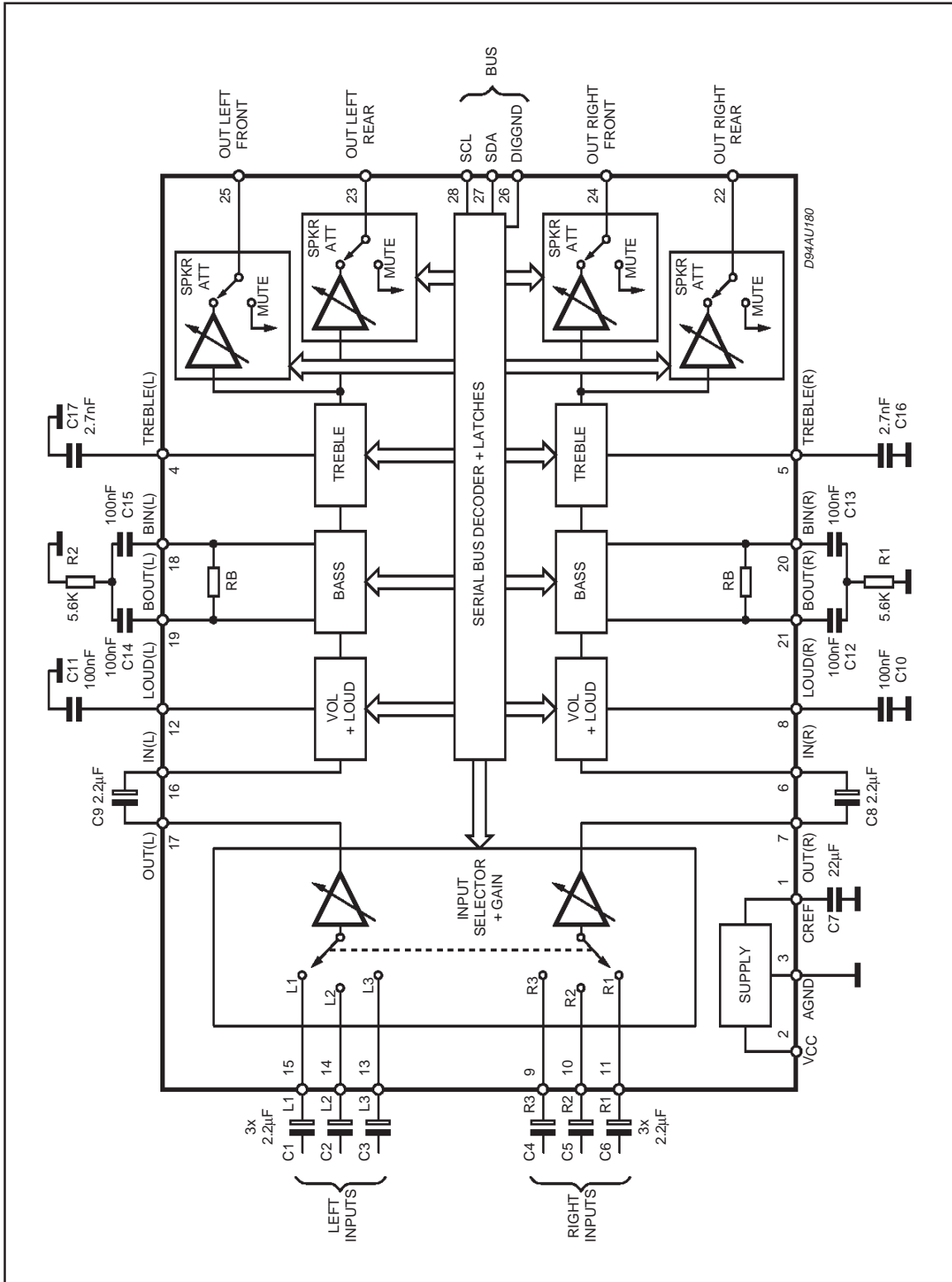

## TDA7313

**ELECTRICAL CHARACTERISTICS** (refer to the test circuit  $T_{amb} = 25^{\circ}\text{C}$ ,  $V_S = 9\text{V}$ ,  $R_L = 10\text{K}\Omega$ ,  $R_G = 600\Omega$ , all controls flat ( $G = 0$ ),  $f = 1\text{KHz}$  unless otherwise specified)

Symbol	Parameter	Test Condition	Min.	Typ.	Max.	Unit
--------	-----------	----------------	------	------	------	------

### SUPPLY

$V_S$	Supply Voltage		6	9	10	V
$I_S$	Supply Current			8	11	mA
SVR	Ripple Rejection		60	80		dB

### INPUT SELECTORS

$R_{II}$	Input Resistance	Input 1, 2, 3	35	50	70	$\text{K}\Omega$
$V_{CL}$	Clipping Level		2	2.5		Vrms
$S_{IN}$	Input Separation (2)		80	100		dB
$R_L$	Output Load resistance	pin 7, 17	2			$\text{K}\Omega$
$G_{INmin}$	Min. Input Gain		-1	0	1	dB
$G_{INmax}$	Max. Input Gain			11.25		dB
$G_{STEP}$	Step Resolution			3.75		dB
$e_{IN}$	Input Noise	$G = 11.25\text{dB}$		2		$\mu\text{V}$
$V_{DC}$	DC Steps	adjacent gain steps		4	20	mV
		$G = 18.75$ to Mute		4		mV

### VOLUME CONTROL

$R_{IV}$	Input Resistance		20	33	50	$\text{k}\Omega$
$C_{RANGE}$	Control Range		70	75	80	dB
$A_{VMIN}$	Min. Attenuation		-1	0	1	dB
$A_{VMAX}$	Max. Attenuation		70	75	80	dB
$A_{STEP}$	Step Resolution		0.5	1.25	1.75	dB
$E_A$	Attenuation Set Error	$A_v = 0$ to $-20\text{dB}$	-1.25	0	1.25	dB
		$A_v = -20$ to $-60\text{dB}$	-3		2	dB
$E_T$	Tracking Error				2	dB
$V_{DC}$	DC Steps	adjacent attenuation steps		0	3	mV
		From 0dB to $A_v$ max		0.5	7.5	mV

### SPEAKER ATTENUATORS

$C_{range}$	Control Range		35	37.5	40	dB
$S_{STEP}$	Step Resolution		0.5	1.25	1.75	dB
$E_A$	Attenuation set error				1.5	dB
$A_{MUTE}$	Output Mute Attenuation		80	100		dB
$V_{DC}$	DC Steps	adjacent att. steps		0	3	mV
		from 0 to mute		1	10	mV

### BASS CONTROL (1)

$G_b$	Control Range	Max. Boost/cut	$\pm 12$	$\pm 14$	$\pm 16$	dB
$B_{STEP}$	Step Resolution		1	2	3	dB
$R_B$	Internal Feedback Resistance		34	44	58	$\text{K}\Omega$

### TREBLE CONTROL (1)

$G_t$	Control Range	Max. Boost/cut	$\pm 13$	$\pm 14$	$\pm 15$	dB
$T_{STEP}$	Step Resolution		1	2	3	dB

**ELECTRICAL CHARACTERISTICS** (continued)

Symbol	Parameter	Test Condition	Min.	Typ.	Max.	Unit
<b>AUDIO OUTPUTS</b>						
$V_{OCL}$	Clipping Level	$d = 0.3\%$	2	2.5		Vrms
$R_L$	Output Load Resistance		2			K $\Omega$
$C_L$	Output Load Capacitance				10	nF
$R_{OUT}$	Output resistance		30	75	120	$\Omega$
$V_{OUT}$	DC Voltage Level		4.2	4.5	4.8	V

**GENERAL**

$e_{NO}$	Output Noise	BW = 20-20KHz, flat output muted all gains = 0dB		2.5 5	15	$\mu$ V $\mu$ V
		A curve all gains = 0dB		3		$\mu$ V
S/N	Signal to Noise Ratio	all gains = 0dB; $V_O = 1V_{rms}$		106		dB
d	Distortion	$A_V = 0, V_{IN} = 1V_{rms}$ $A_V = -20dB, V_{IN} = 1V_{rms}$ $V_{IN} = 0.3V_{rms}$		0.01 0.09 0.04	0.1 0.3	% % %
$S_c$	Channel Separation left/right		80	103		dB
	Total Tracking error	$A_V = 0$ to -20dB -20 to -60 dB		0 0	1 2	dB dB

**BUS INPUTS**

$V_{IL}$	Input Low Voltage				1	V
$V_{IH}$	Input High Voltage		3			V
$I_{IN}$	Input Current		-5		+5	$\mu$ A
$V_O$	Output Voltage SDA Acknowledge	$I_O = 1.6mA$			0.4	V

**Notes:**

- (1) Bass and Treble response see attached diagram (fig.16). The center frequency and quality of the resonance behaviour can be chosen by the external circuitry. A standard first order bass response can be realized by a standard feedback network
- (2) The selected input is grounded thru the 2.2 $\mu$ F capacitor.

**Figure 1:** Loudness vs. Volume Attenuation

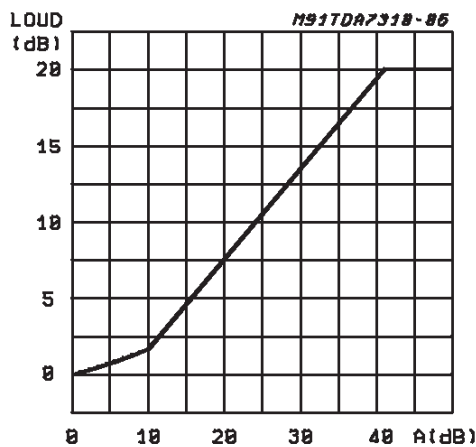

**Figure 2:** Loudness vs. Frequency ( $C_{LOUD} = 100nF$ ) vs. Volume Attenuation

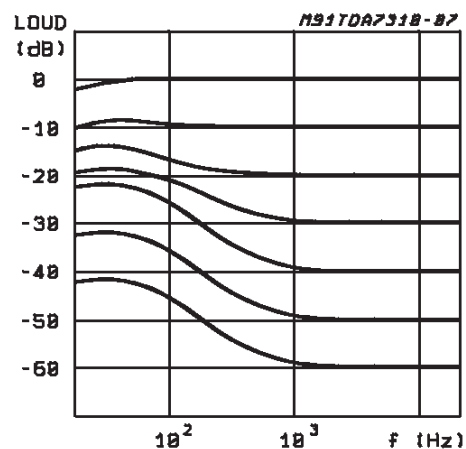

Figure 3: Loudness vs. External Capacitors

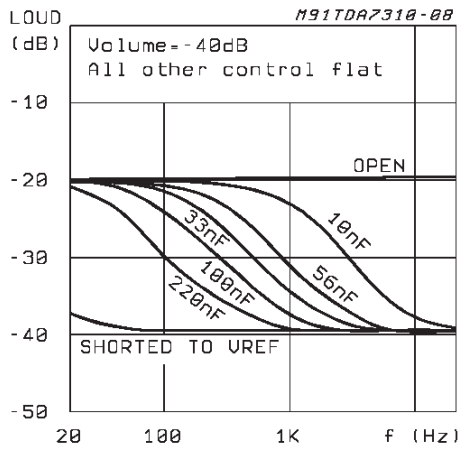

Figure 4: Noise vs. Volume/Gain Settings

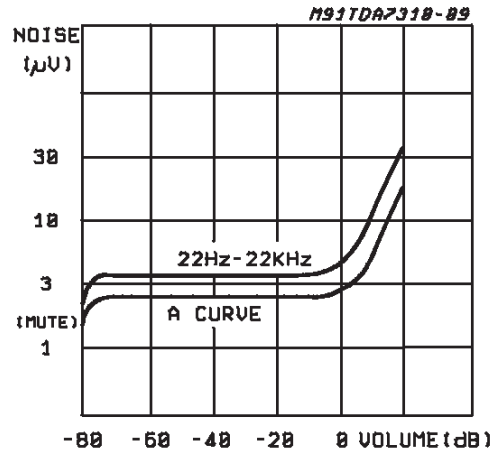

Figure 5: Signal to Noise Ratio vs. Volume Setting

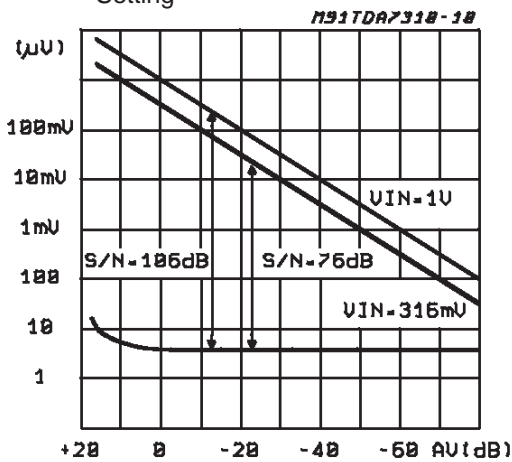

Figure 6: Distortion & Noise vs. Frequency

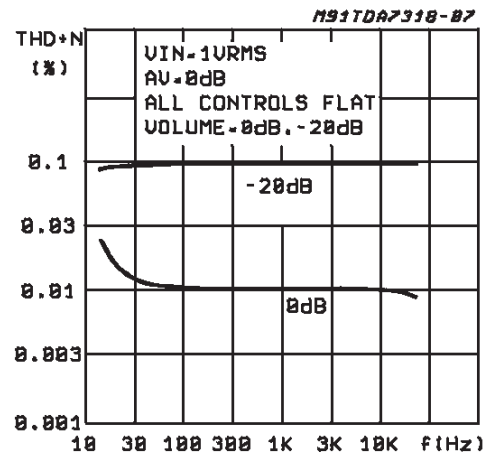

Figure 7: Distortion & Noise vs. Frequency

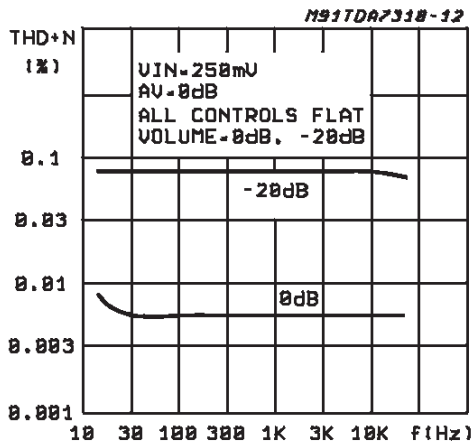
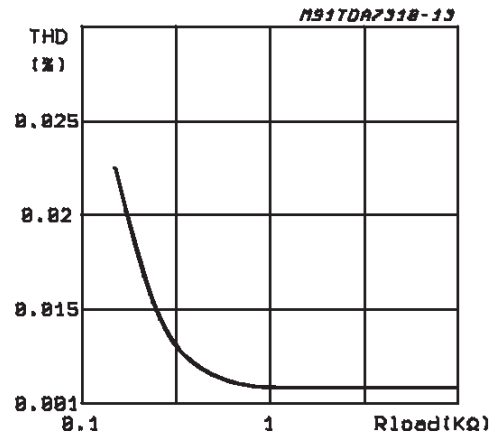
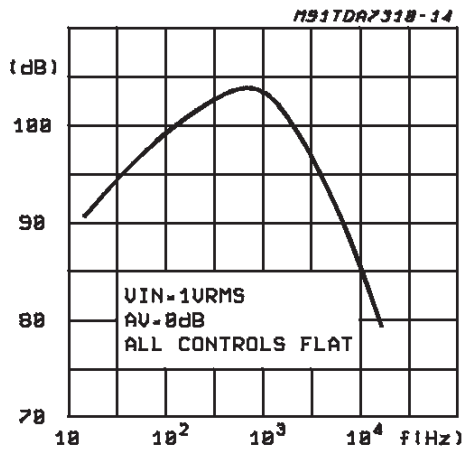

Figure 8: Distortion vs. Load Resistance



**Figure 9:** Channel Separation (L → R) vs. Frequency



**Figure 10:** Input Separation (L1 → L2, L3, L4) vs. Frequency

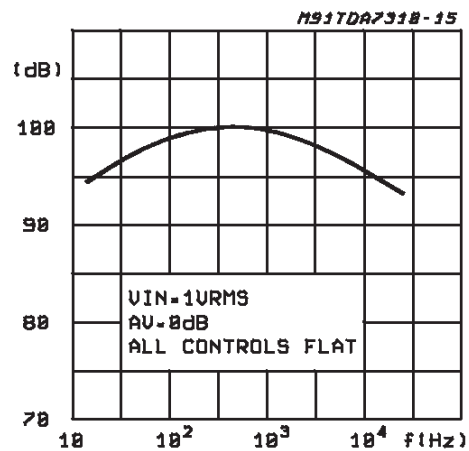

**Figure 11:** Supply Voltage Rejection vs. Frequency

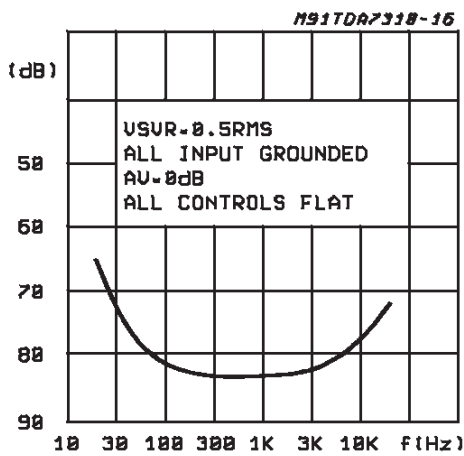

**Figure 12:** Output Clipping Level vs. Supply Voltage

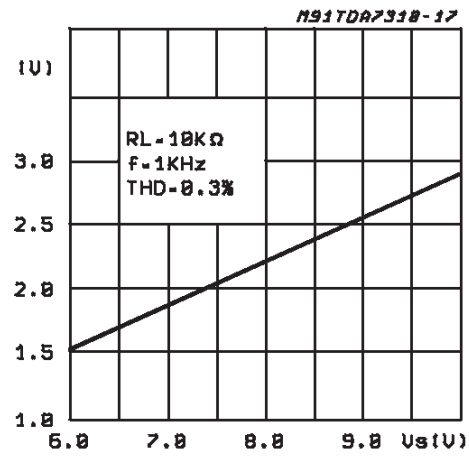

**Figure 13:** Quiescent Current vs. Supply Voltage

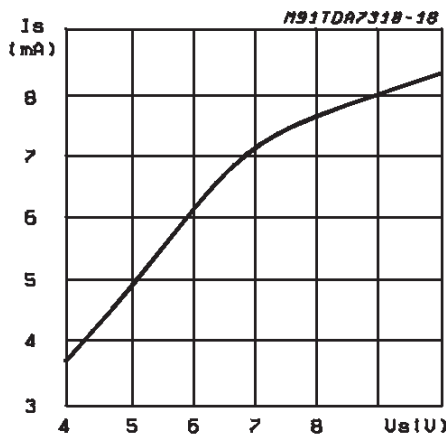

**Figure 14:** Supply Current vs. Temperature

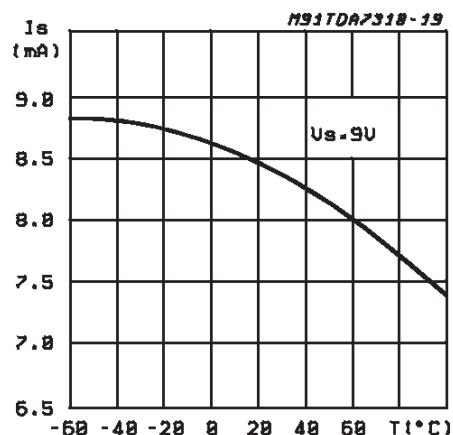
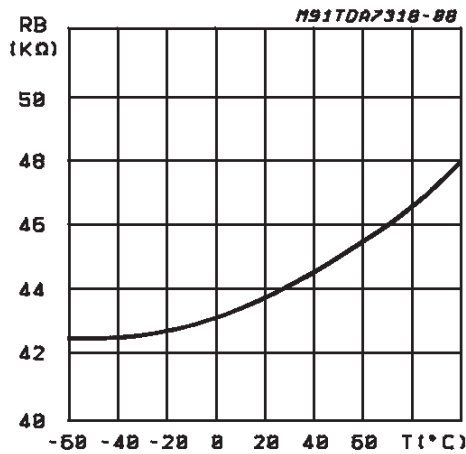

Figure 15: Bass Resistance vs. Temperature



**I<sup>2</sup>C BUS INTERFACE**

Data transmission from microprocessor to the TDA7313 and viceversa takes place thru the 2 wires I<sup>2</sup>C BUS interface, consisting of the two lines SDA and SCL (pull-up resistors to positive supply voltage must be connected).

**Data Validity**

As shown in fig. 17, the data on the SDA line must be stable during the high period of the clock. The HIGH and LOW state of the data line can only change when the clock signal on the SCL line is LOW.

**Start and Stop Conditions**

As shown in fig.18 a start condition is a HIGH to LOW transition of the SDA line while SCL is HIGH. The stop condition is a LOW to HIGH transition of the SDA line while SCL is HIGH.

**Byte Format**

Every byte transferred on the SDA line must contain 8 bits. Each byte must be followed by an acknowledge bit. The MSB is transferred first.

Figure 16: Typical Tone Response (with the ext. components indicated in the test circuit)

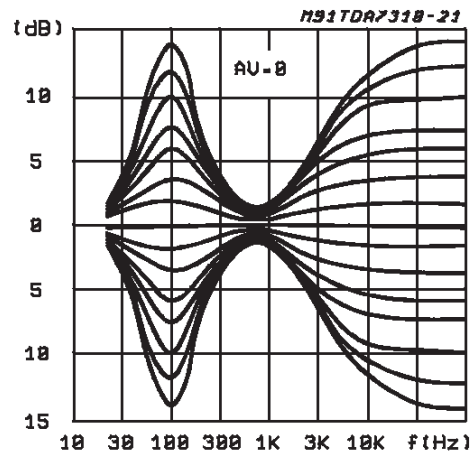

**Acknowledge**

The master ( $\mu$ P) puts a resistive HIGH level on the SDA line during the acknowledge clock pulse (see fig. 19). The peripheral (audioprocessor) that acknowledges has to pull-down (LOW) the SDA line during the acknowledge clock pulse, so that the SDA line is stable LOW during this clock pulse.

The audioprocessor which has been addressed has to generate an acknowledge after the reception of each byte, otherwise the SDA line remains at the HIGH level during the ninth clock pulse time. In this case the master transmitter can generate the STOP information in order to abort the transfer.

**Transmission without Acknowledge**

Avoiding to detect the acknowledge of the audioprocessor, the  $\mu$ P can use a simpler transmission: simply it waits one clock without checking the slave acknowledging, and sends the new data.

This approach of course is less protected from misworking and decreases the noise immunity.

Figure 17: Data Validity on the I<sup>2</sup>C BUS

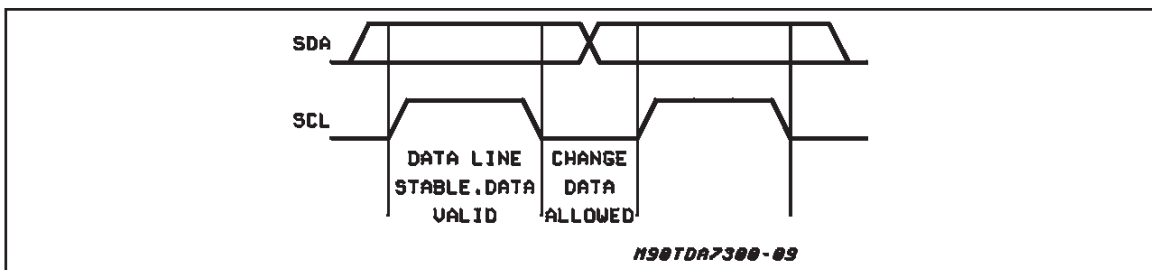



Figure 18: Timing Diagram of I<sup>2</sup>C BUS

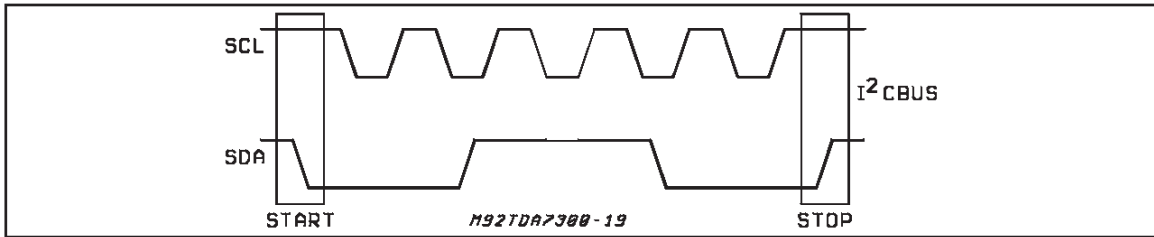
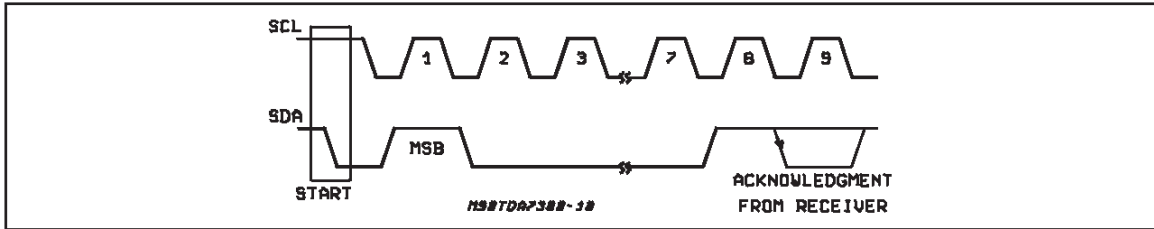

Figure 19: Acknowledge on the I<sup>2</sup>C BUS



**SOFTWARE SPECIFICATION**

**Interface Protocol**

The interface protocol comprises:

- A start condition (s)
- A chip address byte, containing the TDA7313

address (the 8th bit of the byte must be 0). The TDA7313 must always acknowledge at the end of each transmitted byte.

- A sequence of data (N-bytes + acknowledge)
- A stop condition (P)

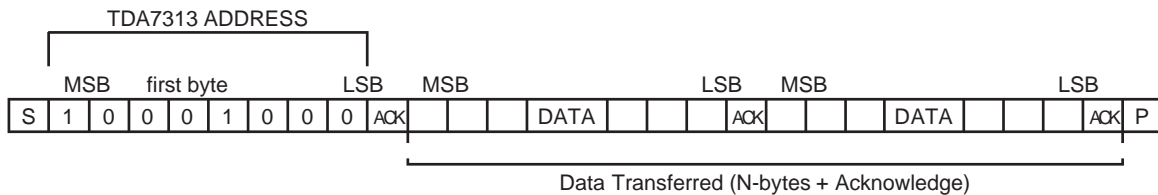

ACK = Acknowledge  
S = Start  
P = Stop

MAX CLOCK SPEED 100kbts/s

**SOFTWARE SPECIFICATION**

Chip address

1	0	0	0	1	0	0	0
MSB							LSB

DATA BYTES

MSB						LSB			FUNCTION
0	0	B2	B1	B0	A2	A1	A0	Volume control	
1	1	0	B1	B0	A2	A1	A0	Speaker ATT LR	
1	1	1	B1	B0	A2	A1	A0	Speaker ATT RR	
1	0	0	B1	B0	A2	A1	A0	Speaker ATT LF	
1	0	1	B1	B0	A2	A1	A0	Speaker ATT RF	
0	1	0	G1	G0	S2	S1	S0	Audio switch	
0	1	1	0	C3	C2	C1	C0	Bass control	
0	1	1	1	C3	C2	C1	C0	Treble control	

Ax = 1.25dB steps; Bx = 10dB steps; Cx = 2dB steps; Gx = 3.75dB steps



**SOFTWARE SPECIFICATION** (continued)

DATA BYTES (detailed description)

**Volume**

MSB						LSB			FUNCTION
0	0		B2	B1	B0	A2	A1	A0	Volume 1.25dB steps
						0	0	0	0
						0	0	1	-1.25
						0	1	0	-2.5
						0	1	1	-3.75
						1	0	0	-5
						1	0	1	-6.25
						1	1	0	-7.5
						1	1	1	-8.75
0	0		B2	B1	B0	A2	A1	A0	Volume 10dB steps
			0	0	0				0
			0	0	1				-10
			0	1	0				-20
			0	1	1				-30
			1	0	0				-40
			1	0	1				-50
			1	1	0				-60
			1	1	1				-70

For example a volume of -45dB is given by:

0 0 1 0 0 1 0 0

**Speaker Attenuators**

MSB						LSB			FUNCTION
1	0	0	B1	B0	A2	A1	A0	Speaker LF	
1	0	1	B1	B0	A2	A1	A0	Speaker RF	
1	1	0	B1	B0	A2	A1	A0	Speaker LR	
1	1	1	B1	B0	A2	A1	A0	Speaker RR	
								0	
								-1.25	
								-2.5	
								-3.75	
								-5	
								-6.25	
								-7.5	
								-8.75	
			0	0				0	
			0	1				-10	
			1	0				-20	
			1	1				-30	
			1	1	1	1	1	Mute	

For example attenuation of 25dB on speaker RF is given by:

1 0 1 1 0 1 0 0

**Audio Switch**

MSB								LSB	FUNCTION
0	1	0	G1	G0	S2	S1	S0	Audio Switch	
						0	0	Stereo 1	
						0	1	Stereo 2	
						1	0	Stereo 3	
						1	1	Stereo 4 (*)	
					0			LOUDNESS ON	
					1			LOUDNESS OFF	
			0	0				+11.25dB	
			0	1				+7.5dB	
			1	0				+3.75dB	
			1	1				0dB	

For example to select the stereo 2 input with a gain of +7.5dB LOUDNESS ON the 8bit string is:

0 1 0 0 1 0 0 1

(\*) Stereo 4 is connected internally, but not available on pins.

**Bass and Treble**

0	1	1	0	C3	C2	C1	C0	Bass Treble
0	1	1	1	C3	C2	C1	C0	
				0	0	0	0	-14
				0	0	0	1	-12
				0	0	1	0	-10
				0	0	1	1	-8
				0	1	0	0	-6
				0	1	0	1	-4
				0	1	1	0	-2
				0	1	1	1	0
				1	1	1	1	0
				1	1	1	0	2
				1	1	0	1	4
				1	1	0	0	6
				1	0	1	1	8
				1	0	1	0	10
				1	0	0	1	12
				1	0	0	0	14

C3 = Sign

For example Bass at -10dB is obtained by the following 8 bit string:

0 1 1 0 0 0 1 0

Purchase of I<sup>2</sup>C Components of STMicroelectronics, conveys a license under the Philips I<sup>2</sup>C Patent Rights to use these components in an I<sup>2</sup>C system, provided that the system conforms to the I<sup>2</sup>C Standard Specifications as defined by Philips.

DIM.	mm			inch		
	MIN.	TYP.	MAX.	MIN.	TYP.	MAX.
A			2.65			0.104
a1	0.1		0.3	0.004		0.012
b	0.35		0.49	0.014		0.019
b1	0.23		0.32	0.009		0.013
C		0.5			0.020	
c1	45° (typ.)					
D	17.7		18.1	0.697		0.713
E	10		10.65	0.394		0.419
e		1.27			0.050	
e3		16.51			0.65	
F	7.4		7.6	0.291		0.299
L	0.4		1.27	0.016		0.050
S	8° (max.)					

**OUTLINE AND MECHANICAL DATA**

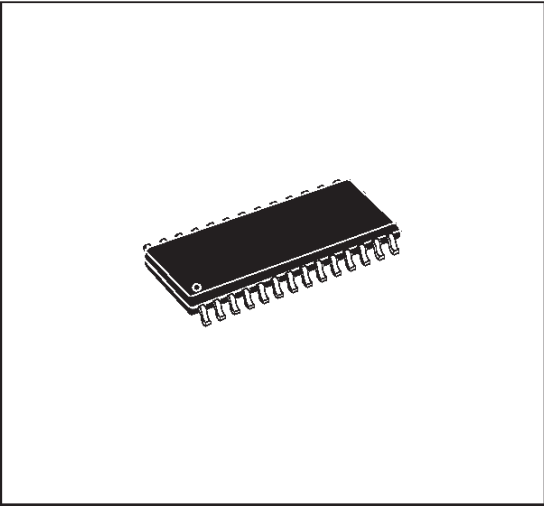

**SO28**

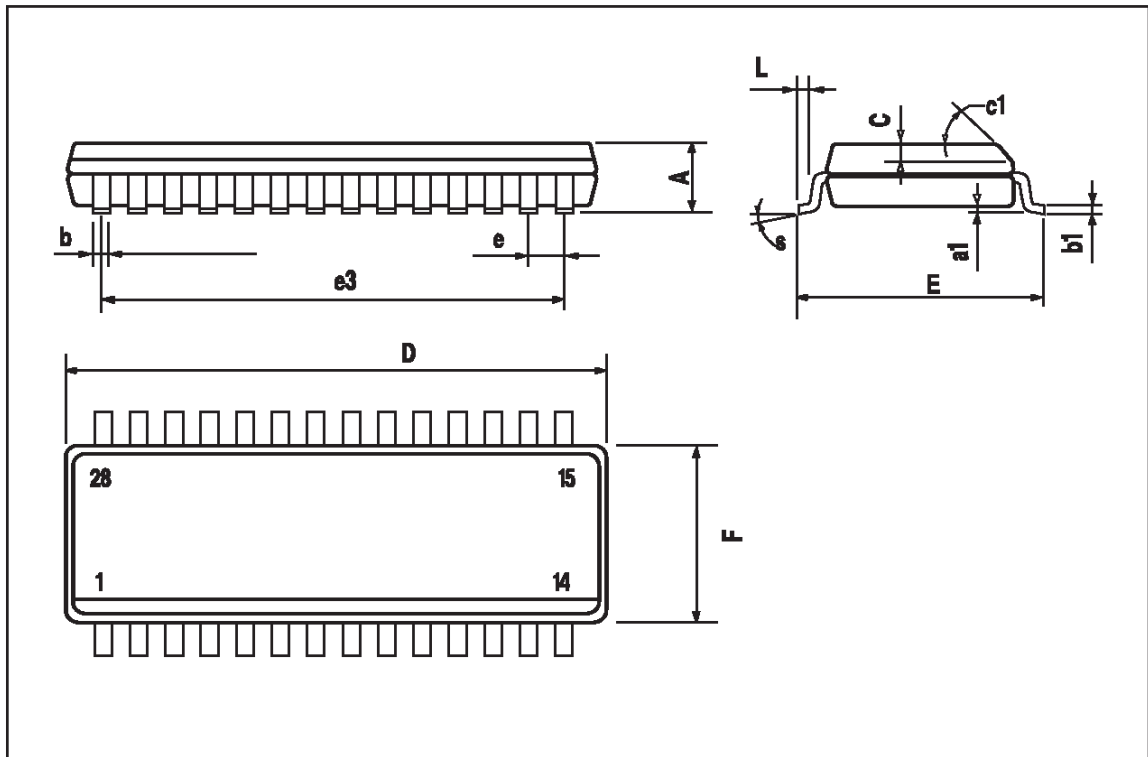

DIM.	mm			inch		
	MIN.	TYP.	MAX.	MIN.	TYP.	MAX.
a1		0.63			0.025	
b		0.45			0.018	
b1	0.23		0.31	0.009		0.012
b2		1.27			0.050	
D			37.34			1.470
E	15.2		16.68	0.598		0.657
e		2.54			0.100	
e3		33.02			1.300	
F			14.1			0.555
I		4.445			0.175	
L		3.3			0.130	

## OUTLINE AND MECHANICAL DATA

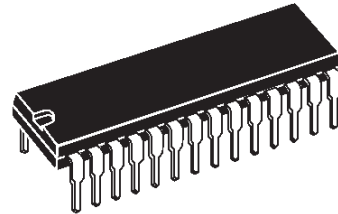

**DIP28**

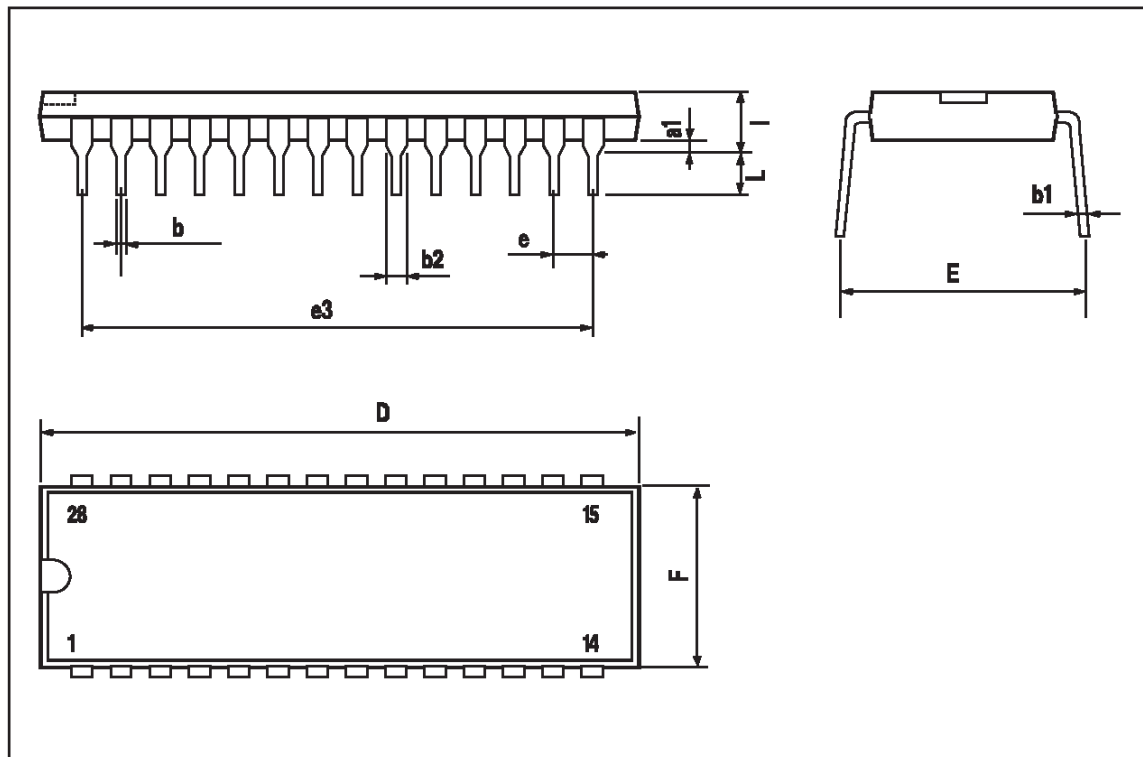

Information furnished is believed to be accurate and reliable. However, STMicroelectronics assumes no responsibility for the consequences of use of such information nor for any infringement of patents or other rights of third parties which may result from its use. No license is granted by implication or otherwise under any patent or patent rights of STMicroelectronics. Specification mentioned in this publication are subject to change without notice. This publication supersedes and replaces all information previously supplied. STMicroelectronics products are not authorized for use as critical components in life support devices or systems without express written approval of STMicroelectronics.

The ST logo is a registered trademark of STMicroelectronics

© 1999 STMicroelectronics – Printed in Italy – All Rights Reserved

STMicroelectronics GROUP OF COMPANIES

Australia - Brazil - China - Finland - France - Germany - Hong Kong - India - Italy - Japan - Malaysia - Malta - Morocco -  
Singapore - Spain - Sweden - Switzerland - United Kingdom - U.S.A.

<http://www.st.com>